

Article number: 51030483000010

Description: Vibration damper GS-M2
110x40x2000-15, NR shore 57

Measures

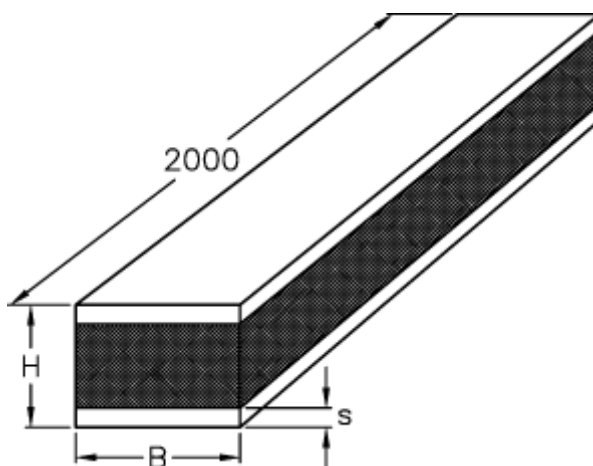

B = 110

H = 40

S = 15